



+



+

Not included / Non incluso / Non inclus / Nie zawarty / No incluido / Não incluido

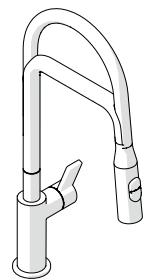

B

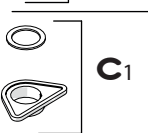

C1



C

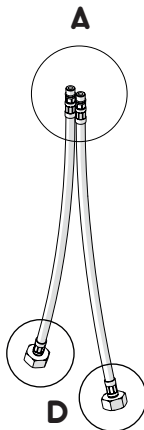

A

D

1

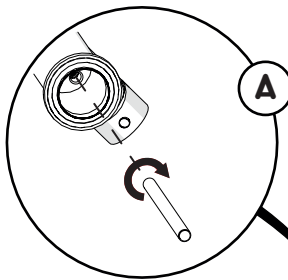
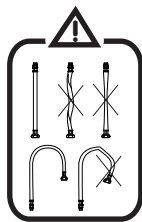
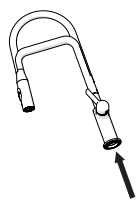

A

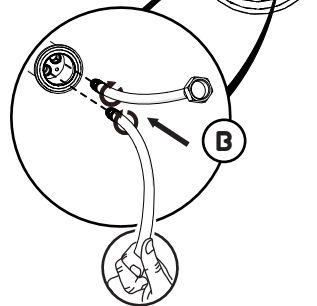
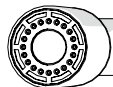

B

3



-50%

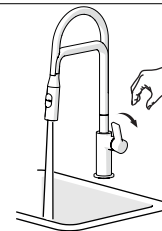
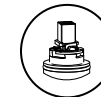
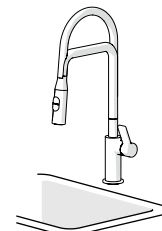

ON 50%

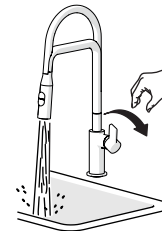

ON 100%

5

2

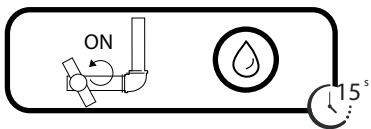

15^s

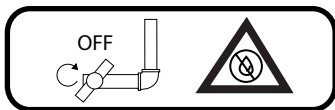
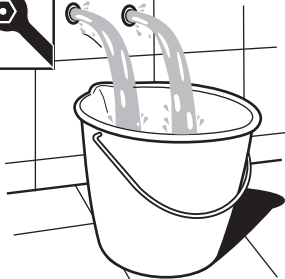

OFF



4

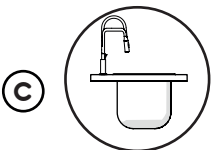

C

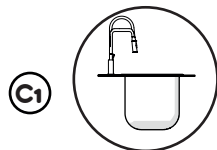
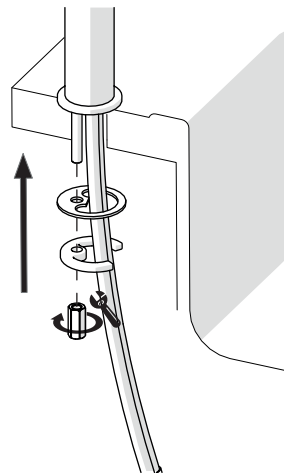

C1

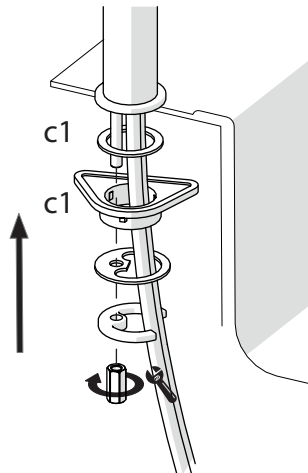

c1

c1

6

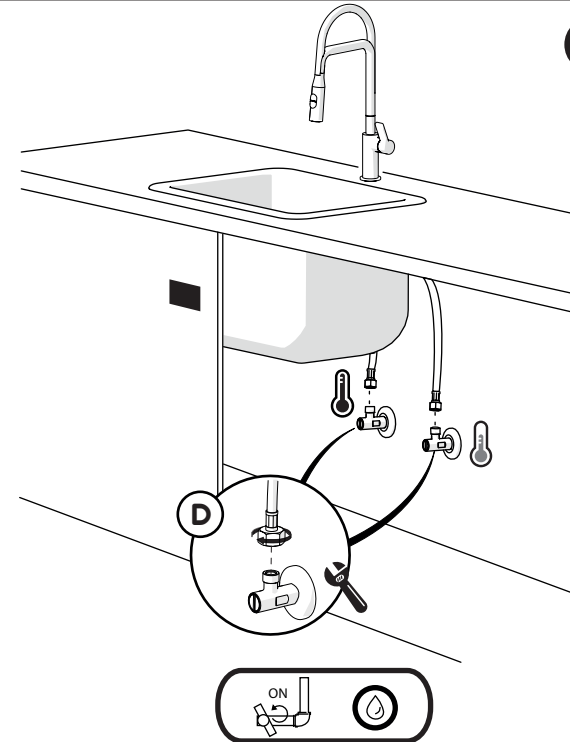

D

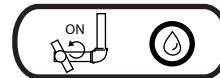

ON

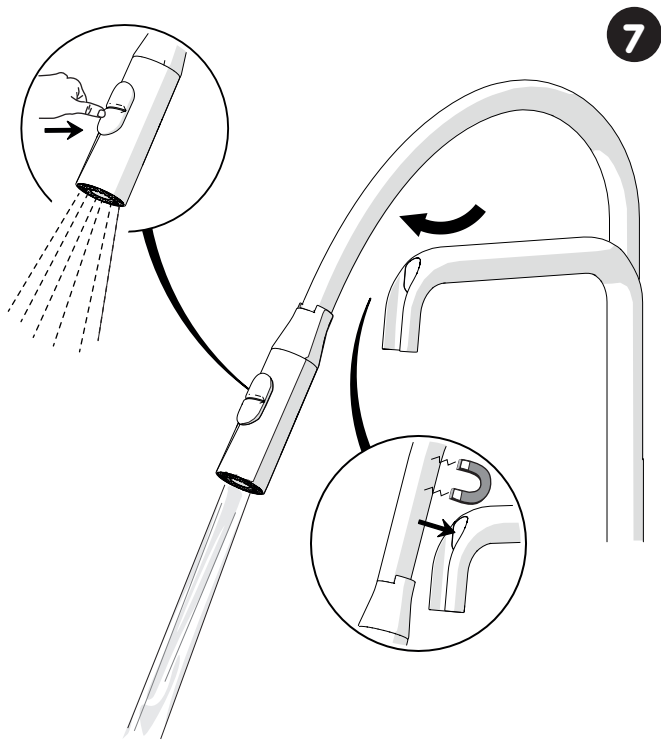

7

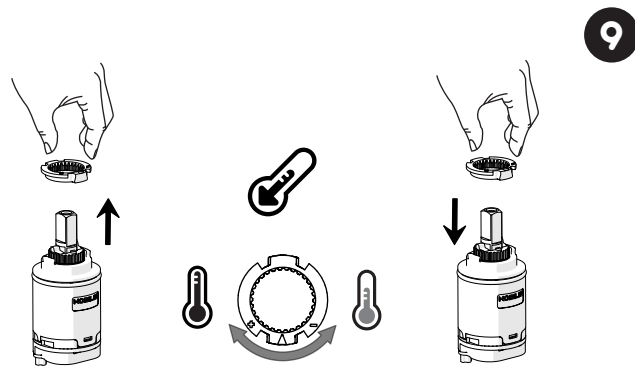

9

No limitation of temperature

Partial limitation of temperature

Maximum position Only cold water

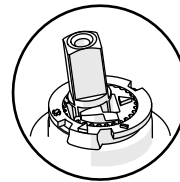
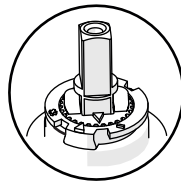
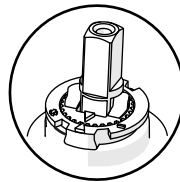

NOBILIS
The Best Technology for Water

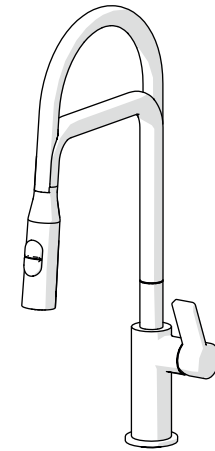

FL96400



IISTRFL96400#---STD

www.grupponobili.it

REV02/2013

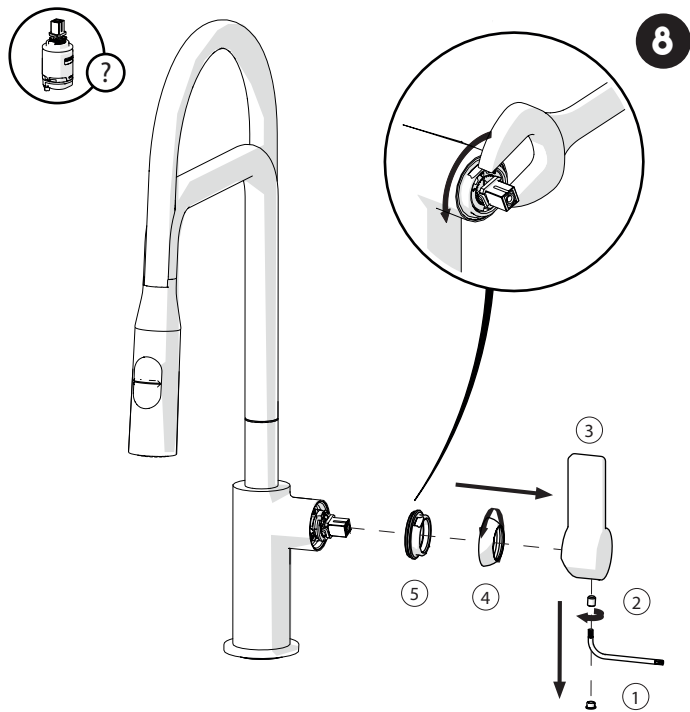

8

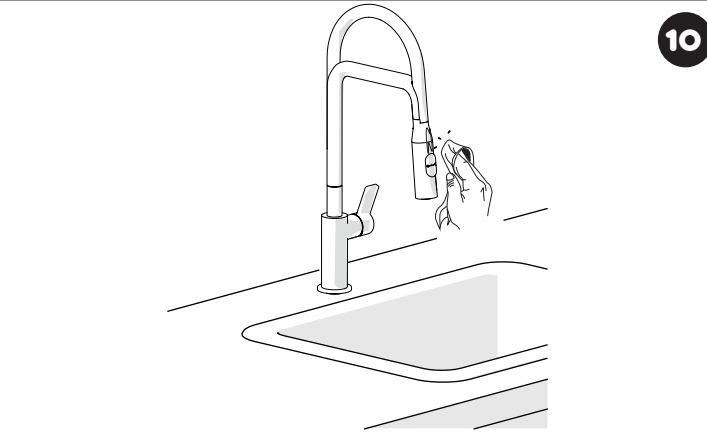

10

CLEANING

